

Scanning distance
30 ... 1,100 mm

Photoelectric proximity switch

- Precise background suppression without scanning distance drift
- Reliable in industrial environments; secure against the effects of ambient light, unwanted optical reflections, other sensors mounted adjacently and temperatures from -40 °C ... +60 °C
- Easy Teach-in, simple and fast commissioning



Dimensional drawing

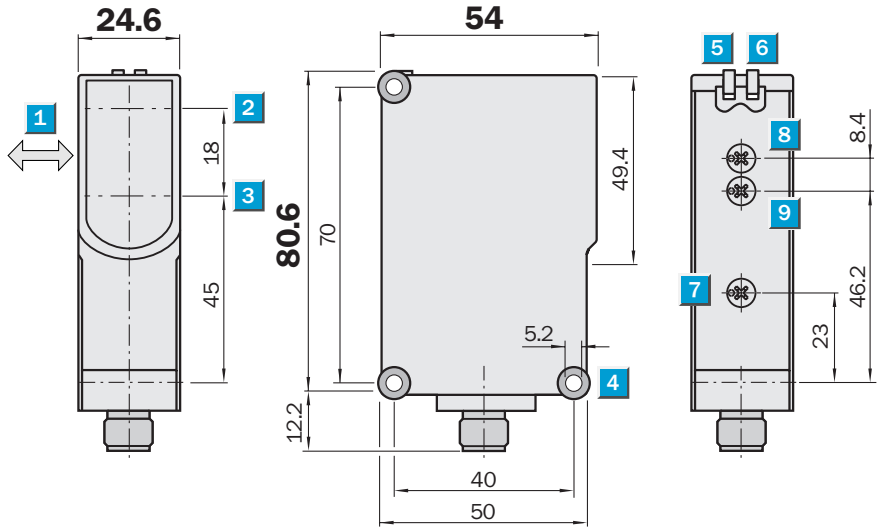

Adjustments possible

WTB27-3P2441	WTB27-3P2443
WTB27-3P3741	

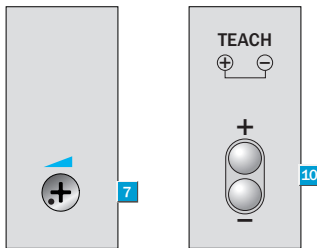

WTB27-3E2641
WTB27-3F2641

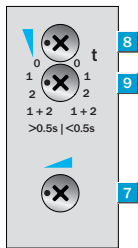

- 1 Standard direction of the material being scanned
- 2 Optical axis sender
- 3 Optical axis receiver
- 4 Mounting hole Ø 5.2 mm
- 5 LED indicator green; power on
- 6 LED indicator yellow; status of received light beam
- 7 Adjustment of scanning distance: Poti
- 8 Time control
- 9 Time delay selector switch
- 10 Adjustment of scanning distance: double teach button

Switch-selectable time delay

0.02 - 0.5s or 0.5 - 10s

- 0 Without time delay
- 1 Time delay from trailing edge of object
- 2 Time delay from leading edge of object
- 1 + 2 Time delay from trailing and leading edge of object



Connection type

WTB27-3P3741	WTB27-3P2441	WTB27-3E2641
	WTB27-3P2443	WTB27-3F2641

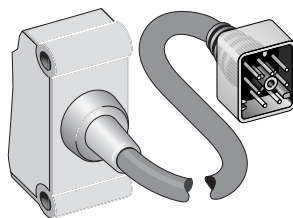

Q7, 7-pin, DC

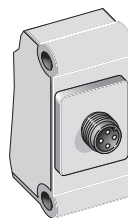

M12, 4-pin

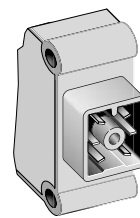

Q6, 6-pin, DC

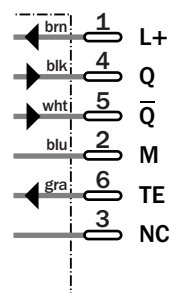
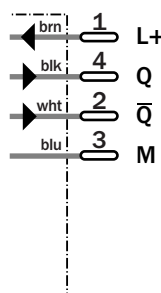
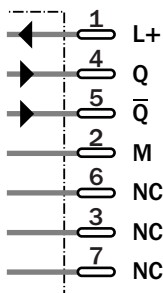

See chapter Accessories

Connector, M12, 4-pin
Connector, Q6, 6-pin, DC-coding
Connector, Q7, 7-pin, DC-coding
Mounting systems
Weather protection

Technical data		WTB27-3	E2641	F2641	P2441	P2443	P3741						
Scanning distance typ. max.	30 ... 1,100 mm ¹⁾												
Operating distance	100 ... 1,100 mm ¹⁾												
Adjustment of operating distance	Potentiometer Teach-in: double teach button												
Light source, light type	LED, Red light, 660 nm ²⁾												
Light spot diameter	Approx. 15 mm at 500 mm distance												
Supply voltage V _s	10 ... 30 V DC ³⁾												
Ripple	≤ 5 V _{pp} ⁴⁾												
Power consumption	≤ 35 mA ⁵⁾												
Switching outputs	NPN antivalent PNP antivalent												
Signal voltage PNP HIGH / LOW	> V _s - 2.5 V / approx. 0 V												
Signal voltage NPN HIGH / LOW	Approx. V _s / < 2.5 V												
Output current I _a max	100 mA												
Response time	≤ 1.5 ms ⁶⁾												
Switching frequency	350 Hz ⁷⁾												
Time delay	Selectable: 0.5 ... 10 s / 0.02 ... 0.5 s												
Time type	OFF, T _{off} , T _{on} , T _{off} + T _{on}												
Test input sender off	TE to V _s TE to 0 V												
Connection type	Connector, Q6, 6-pin, DC Connector, M12, 4-pin Cable with plug, Q7, 7-pin, DC, PVC, 150 mm ⁸⁾												
VDE protection class	□ ⁹⁾												
Circuit protection	V _s connections reverse-polarity protected / All outputs short-circuit protected / Interference suppression												
Enclosure rating	IP 65 IP 66, IP 67												
Ambient temperature operation	-40 °C ... +60 °C												
Ambient temperature storage	-40 °C ... +75 °C												
Weight	Approx. 100 g Approx. 120 g												
Housing material	ABS, PMMA												

¹⁾ Object with 90 % remission (based on standard white to DIN 5033)
²⁾ Average service life 100,000 h

at T_a = +25 °C
³⁾ Limit values, operation in short-circuit protected network max. 8 A

⁴⁾ may not exceed or fall short of V_s tolerances
⁵⁾ without load

⁶⁾ Signal transit time with resistive load
⁷⁾ with light/dark ratio 1:1
⁸⁾ do not bend below 0 °C
⁹⁾ Reference voltage 50 V DC

Scanning distance

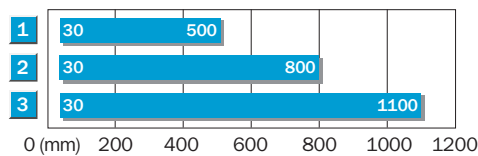

- 1 Scanning distance on black, 6 % remission
- 2 Scanning distance on grey, 18 % remission
- 3 Scanning distance on white, 90 % remission

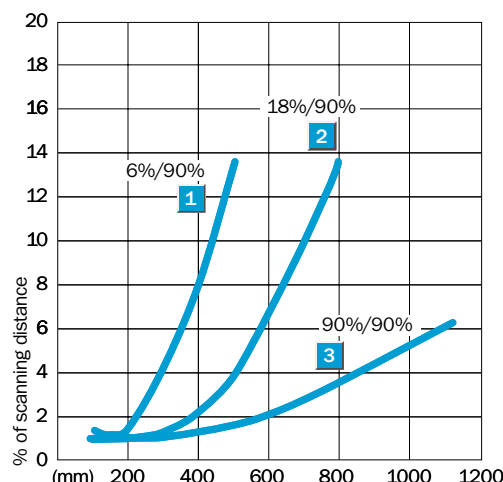

Order information

Type	Order no.
WTB27-3E2641	1 027 747
WTB27-3F2641	1 027 746
WTB27-3P2441	1 027 744
WTB27-3P2443	1 027 745
WTB27-3P3741	1 027 748

Photoelectric proximity switch, WTB27-3, BGS, red light - UC

Scanning distance
30 ... 1,100 mm

Photoelectric proximity switch

- Universal supply voltage
- High-precision background suppression without scanning distance drift
- Reliable in industrial environments; secure against the effects of ambient light, unwanted optical reflections, other sensors mounted adjacently and temperatures from -40 °C ... +60 °C



Dimensional drawing

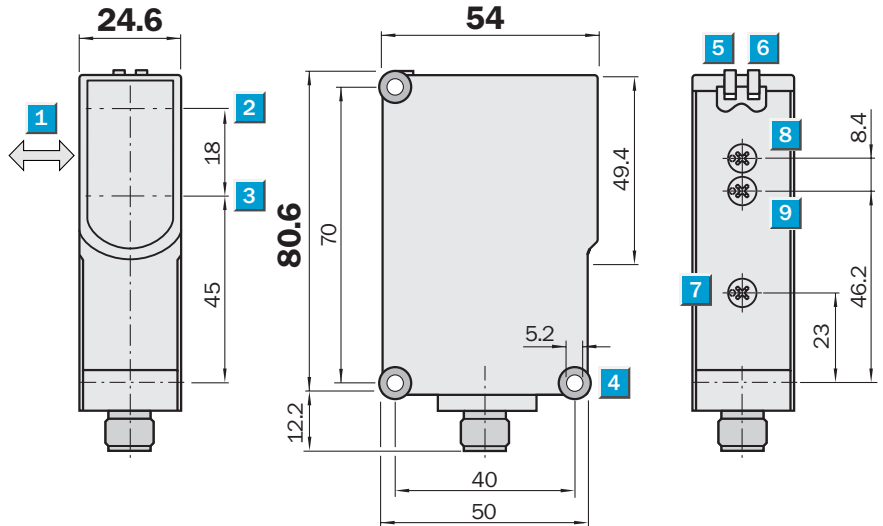

Adjustments possible

WTB27-3S1541	WTB27-3R2641
WTB27-3S3741	

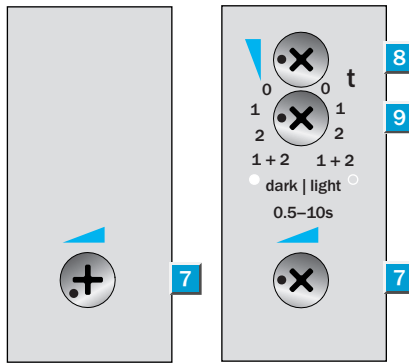

- 1 Standard direction of the material being scanned
- 2 Optical axis sender
- 3 Optical axis receiver
- 4 Mounting hole Ø 5.2 mm
- 5 LED indicator green; power on
- 6 LED indicator yellow; status of received light beam
- 7 Adjustment of scanning distance: Poti
- 8 Time control
- 9 Time delay selector switch
- 0 Light-switching (L)
- Dark-switching (D)

Switch-selectable time delay

D L	0.5 - 10s
0 0	Without time delay
2 1	Time delay from trailing edge of object
1 2	Time delay from leading edge of object
1 + 2	Time delay from trailing and leading edge of object

Connection type

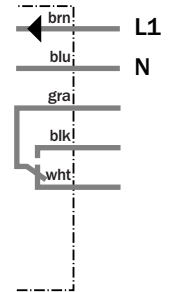
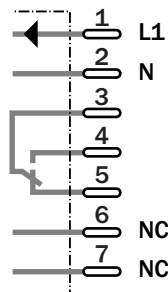
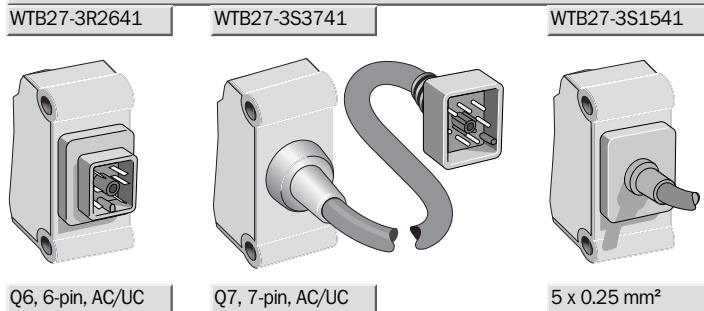

See chapter Accessories*

Connector, Q6, 6-pin, UC-coding
Connector, Q7, 7-pin, UC-coding
Mounting systems
Weather protection

* Recommendation for connectors:



Technical data		WTB27-3	R2641	S1541	S3741							
Scanning distance typ. max.	30 ... 1,100 mm ¹⁾											
Operating distance	100 ... 1,100 mm ¹⁾											
Adjustment of operating distance	Potentiometer											
Light source, light type	LED, Red light, 660 nm ²⁾											
Light spot diameter	Approx. 15 mm at 500 mm distance											
Supply voltage V _s	24 ... 240 V UC ³⁾											
Switching outputs	Relay 1 x c/o, electrically isolated ⁴⁾											
	Relay 1 x c/o, electrically isolated ⁵⁾											
Switching mode	Light-/dark-switching, switchable											
	Light-switching											
Power consumption	≤ 2.5 VA											
Max. switching voltage	250 V AC / 250 V DC (max. 0.11 A)											
Switching current max.	3 A @ 250 V AC o. 24 V DC ⁶⁾											
Max. switching power	750 W AC / 72 W DC											
Response time	≤ 10 ms											
Switching frequency	10 Hz ⁷⁾											
Time delay	Selectable: 0.5 ... 10 s											
Time type	OFF, T _{off} , T _{on} , T _{off} + T _{on}											
Connection type	Connector, Q6, 6-pin, AC/UC											
	Cable, PVC, 2 m ⁸⁾											
	Cable with plug, Q7, 7-pin, AC/UC, PVC, 150 mm ⁸⁾											
VDE protection class	□ ⁹⁾											
Circuit protection	V _s connections reverse-polarity protected / Interference suppression											
Enclosure rating	IP 65											
	IP 66, IP 67											
Ambient temperature operation	-40 °C ... +60 °C ¹⁰⁾											
Ambient temperature storage	-40 °C ... +75 °C											
Weight	Ca. 120 g											
	Approx. 200 g											
	Approx. 140 g											
Housing material	ABS, PMMA											

¹⁾ Object with 90 % remission (based on standard white to DIN 5033)

²⁾ Average service life 100,000 h at T_a = +25 °C

³⁾ ± 10 %

⁴⁾ Provide suitable spark suppression for inductive or capacitive loads. Relay contacts are separated from the power supply by a basic isolation of 3 mm. Depending on the application, additional

isolation might have to be applied in the user's circuit

⁵⁾ Provide suitable spark suppression for inductive or capacitive loads

⁶⁾ Usage category to EN 60947-1,

AC-15, DC-13

⁷⁾ with light/dark ratio 1:1

⁸⁾ do not bend below 0 °C

⁹⁾ Reference voltage 250 V AC

¹⁰⁾ UL: 0 °C ... +60 °C

Scanning distance

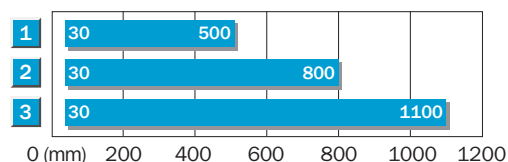

- 1 Scanning distance on black, 6 % remission
- 2 Scanning distance on grey, 18 % remission
- 3 Scanning distance on white, 90 % remission

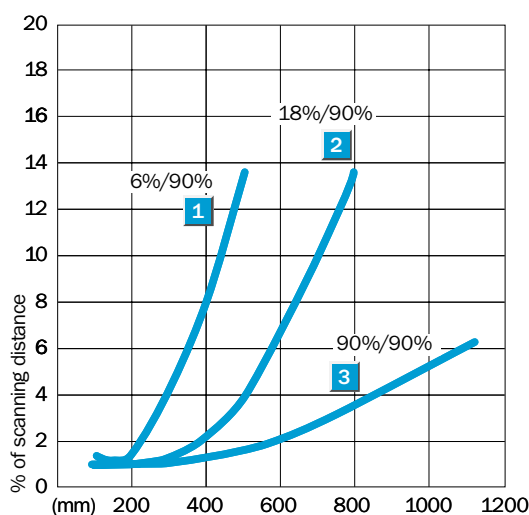

Order information

Type	Order no.
WTB27-3R2641	1 027 750
WTB27-3S1541	1 027 749
WTB27-3S3741	1 027 751

Scanning distance
30 ... 1,600 mm

Photoelectric proximity switch

- Infrared light, very long scanning distance
- Reliable in industrial environments; secure against the effects of ambient light, unwanted optical reflections, other sensors mounted adjacently and temperatures from -40 °C ... +60 °C
- Time delays, test input, front screen heating



Dimensional drawing

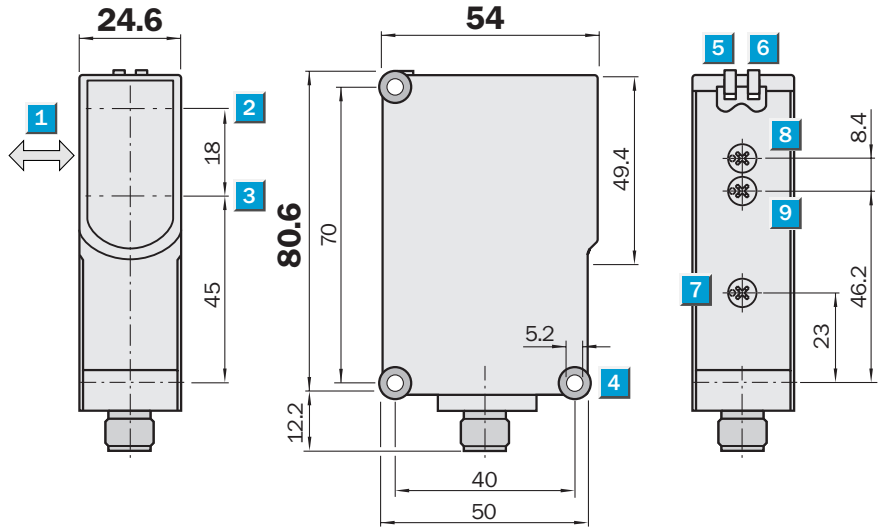

Adjustments possible

WTB27-3P1111	WTB27-3E2411
WTB27-3P2411	WTB27-3E2611
WTB27-3P2421	WTB27-3F2411
WTB27-3P3711	WTB27-3F2611

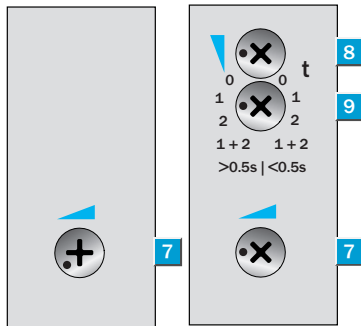

- 1 Standard direction of the material being scanned
- 2 Optical axis sender
- 3 Optical axis receiver
- 4 Mounting hole Ø 5.2 mm
- 5 LED indicator green; power on
- 6 LED indicator yellow; status of received light beam
- 7 Adjustment of scanning distance: Poti
- 8 Time control
- 9 Time delay selector switch

Switch-selectable time delay

0.02 - 0.5s or 0.5 - 10s

- 0 Without time delay
- 1 Time delay from trailing edge of object
- 2 Time delay from leading edge of object
- 1 + 2 Time delay from trailing and leading edge of object



Connection type

WTB27-3P3711	WTB27-3E2411	WTB27-3E2611	WTB27-3P1111
	WTB27-3F2411	WTB27-3F2611	
	WTB27-3P2411		
	WTB27-3P2421		

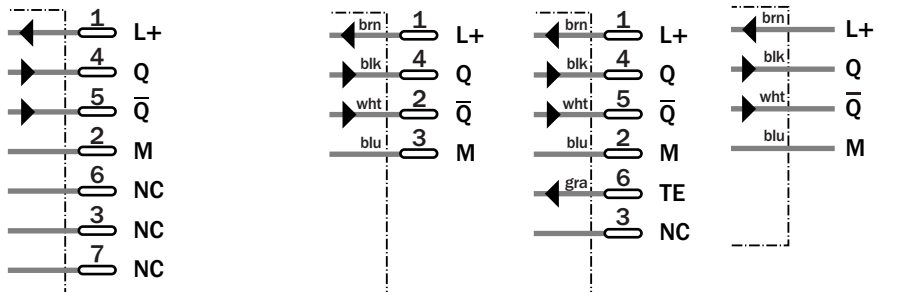
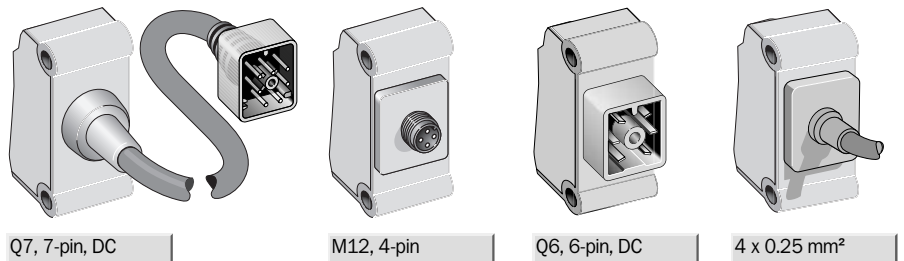

See chapter Accessories

Connector, M12, 4-pin
Connector, Q6, 6-pin, DC-coding
Connector, Q7, 7-pin, DC-coding
Mounting systems
Weather protection

Technical data		WTB27-3	E2411	E2611	F2411	F2611	P1111	P2411	P2421	P3711		
Scanning distance typ. max.	30 ... 1,600 mm ¹⁾											
Operating distance	100 ... 1,600 mm ¹⁾											
Adjustment of operating distance	Potentiometer											
Light source, light type	LED, Infrared light, 880 nm ²⁾											
Light spot diameter	Approx. 25 mm at 800 mm distance											
Supply voltage V_s	10 ... 30 V DC ³⁾											
Ripple	≤ 5 V _{pp} ⁴⁾											
Power consumption	≤ 40 mA ⁵⁾											
	≤ 55 mA ⁵⁾											
Switching outputs	NPN antivalent											
	PNP antivalent											
Signal voltage PNP HIGH / LOW	> V _s - 2.5 V / approx. 0 V											
Signal voltage NPN HIGH / LOW	Approx. V _s / < 2.5 V											
Output current I _a max	100 mA											
Response time	≤ 1.5 ms ⁶⁾											
Switching frequency	350 Hz ⁷⁾											
Time delay	Selectable: 0.5 ... 10 s / 0.02 ... 0.5 s											
Time type	OFF, T _{off} , T _{on} , T _{off} + T _{on}											
Test input sender off	TE to V _s											
	TE to 0 V											
Connection type	Connector, M12, 4-pin											
	Connector, Q6, 6-pin, DC											
	Cable, PVC, 2 m ⁸⁾											
	Cable with plug, Q7, 7-pin, DC, PVC, 150 mm ⁸⁾											
VDE protection class	□ ⁹⁾											
Circuit protection	V _s connections reverse-polarity protected / All outputs short-circuit protected / Interference suppression											
Enclosure rating	IP 66, IP 67											
	IP 65											
Ambient temperature operation	-40 °C ... +60 °C											
Ambient temperature storage	-40 °C ... +75 °C											
Weight	Approx. 100 g											
	Approx. 180 g											
	Approx. 120 g											
Front screen heating	✓											
Housing material	ABS, PMMA											

1) Object with 90 % remission (based on standard white to DIN 5033)
2) Average service life 100,000 h

3) at T_a = +25 °C
3) Limit values, operation in short-circuit protected network max. 8 A

4) may not exceed or fall short of V_s tolerances
5) without load

6) Signal transit time with resistive load
7) with light/dark ratio 1:1
8) do not bend below 0 °C
9) Reference voltage 50 V DC

Scanning distance

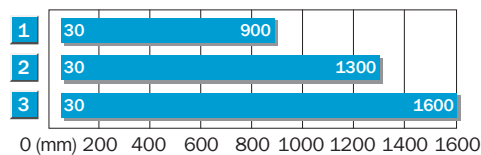

- 1 Scanning distance on black, 6% remission
- 2 Scanning distance on grey, 18% remission
- 3 Scanning distance on white, 90% remission

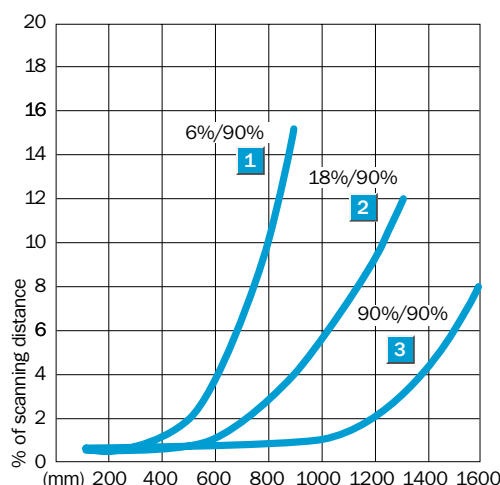

Order information	
Type	Order no.
WTB27-3E2411	1 027 755
WTB27-3E2611	1 027 757
WTB27-3F2411	1 027 753
WTB27-3F2611	1 027 756
WTB27-3P1111	1 027 752
WTB27-3P2411	1 025 994
WTB27-3P2421	1 027 754
WTB27-3P3711	1 027 758

Scanning distance
30 ... 1,600 mm

Photoelectric proximity switch

- Infrared light, very long scanning distance
- Easy Teach-in, simple and fast commissioning
- Reliable in industrial environments; secure against the effects of ambient light, unwanted optical reflections, other sensors mounted adjacently and temperatures from -40 °C ... +60 °C

Dimensional drawing

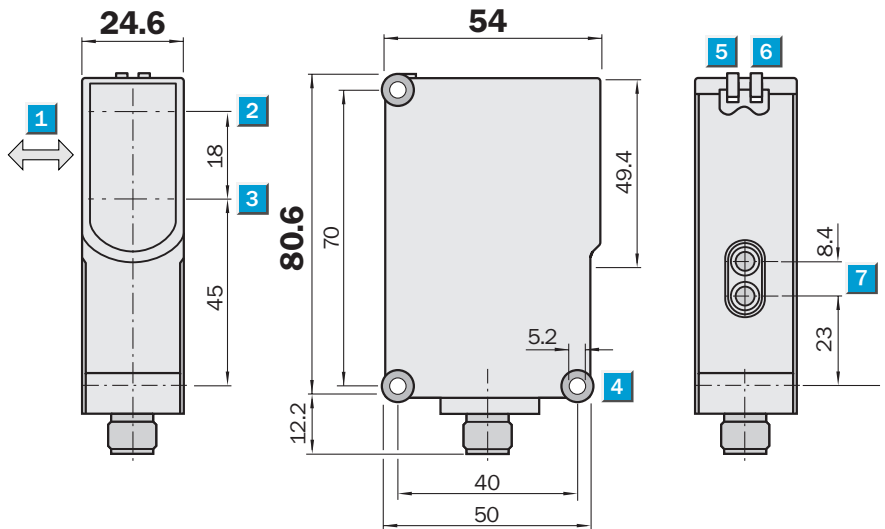

Adjustments possible

- WTB27-3N2413
- WTB27-3P1113
- WTB27-3P2413

- 1 Standard direction of the material being scanned
- 2 Optical axis sender
- 3 Optical axis receiver
- 4 Mounting hole Ø 5.2 mm
- 5 LED indicator green; power on
- 6 LED indicator yellow; status of received light beam
- 7 Adjustment of scanning distance: double teach button

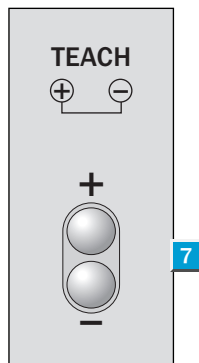

Connection type

- WTB27-3N2413
- WTB27-3P2413

WTB27-3P1113

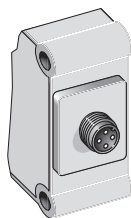

M12, 4-pin

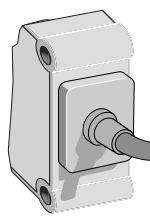

4 x 0.25 mm²

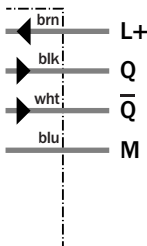
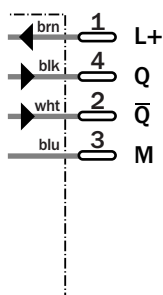

See chapter Accessories

- Connector, M12, 4-pin
- Mounting systems
- Weather protection

Technical data		WTB27-3	N2413	P1113	P2413
Scanning distance typ. max.	30 ... 1,600 mm ¹⁾				
Operating distance	100 ... 1,600 mm ¹⁾				
Adjustment of operating distance	Teach-in: double teach button				
Light source, light type	LED, Infrared light, 880 nm ²⁾				
Light spot diameter	Approx. 25 mm at 800 mm distance				
Supply voltage V _s	10 ... 30 V DC ³⁾				
Ripple	≤ 5 V _{pp} ⁴⁾				
Power consumption	≤ 40 mA ⁵⁾				
Switching outputs	NPN antivalent				
	PNP antivalent				
Signal voltage PNP HIGH / LOW	> V _s - 2.5 V / approx. 0 V				
Signal voltage NPN HIGH / LOW	Approx. V _s / < 2.5 V				
Output current I _a max	100 mA				
Response time	≤ 1.5 ms ⁶⁾				
Switching frequency	350 Hz ⁷⁾				
Connection type	Connector, M12, 4-pin				
	Cable, PVC, 2 m ⁸⁾				
VDE protection class	□ ⁹⁾				
Circuit protection	V _s connections reverse-polarity protected / All outputs short-circuit protected / Interference suppression				
Enclosure rating	IP 66, IP 67				
Ambient temperature operation	-40 °C ... +60 °C				
Ambient temperature storage	-40 °C ... +75 °C				
Weight	Approx. 100 g				
	Approx. 180 g				
Housing material	ABS, PMMA				

¹⁾ Object with 90 % remission (based on standard white to DIN 5033)
²⁾ Average service life 100,000 h

at T_a = +25 °C
³⁾ Limit values, operation in short-circuit protected network max. 8 A

⁴⁾ may not exceed or fall short of V_s tolerances
⁵⁾ without load

⁶⁾ Signal transit time with resistive load
⁷⁾ with light/dark ratio 1:1
⁸⁾ do not bend below 0 °C
⁹⁾ Reference voltage 50 V DC

Scanning distance

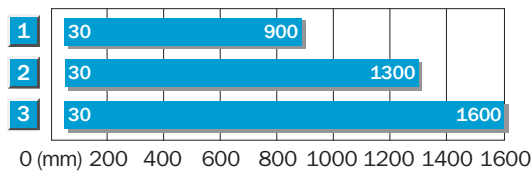

- 1 Scanning distance on black, 6 % remission
- 2 Scanning distance on grey, 18 % remission
- 3 Scanning distance on white, 90 % remission

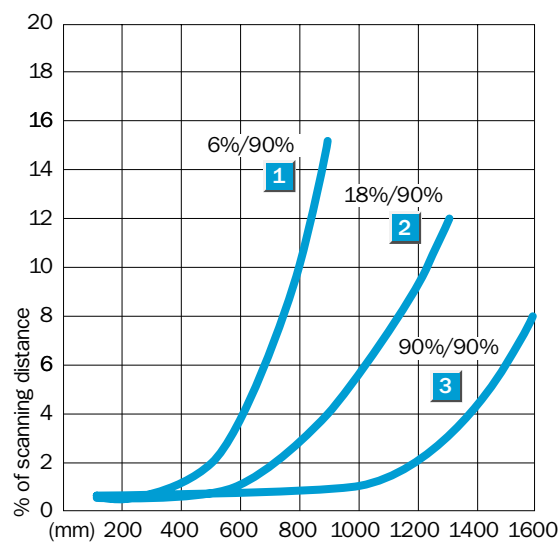

Ordering information

Type	Order no.
WTB27-3N2413	1 027 761
WTB27-3P1113	1 027 759
WTB27-3P2413	1 027 760

Scanning distance
30 ... 1,600 mm

Photoelectric proximity switch

- Universal supply voltage
- Infrared light, very long scanning distance
- Reliable in industrial environments; secure against the effects of ambient light, unwanted optical reflections, other sensors mounted adjacently and temperatures from -40 °C ... +60 °C
- Time delays



Dimensional drawing

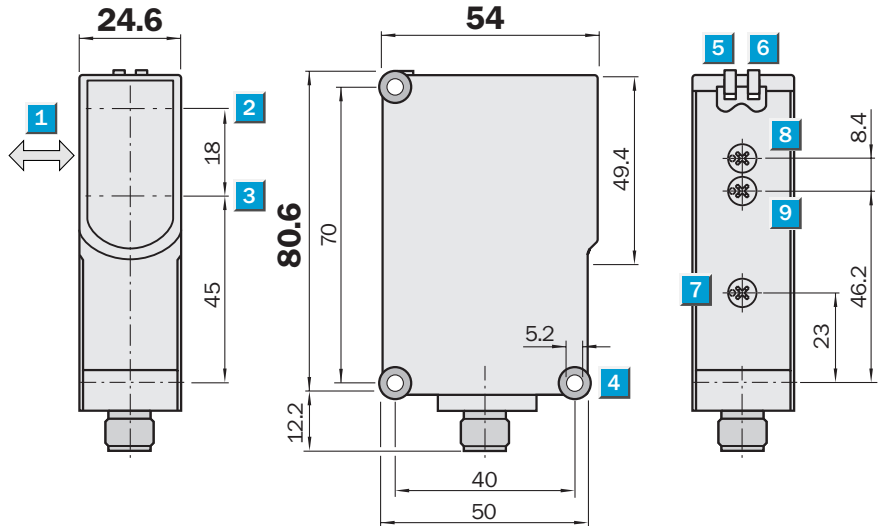

Adjustments possible

WTB27-3S1511	WTB27-3R2611
WTB27-3S3711	

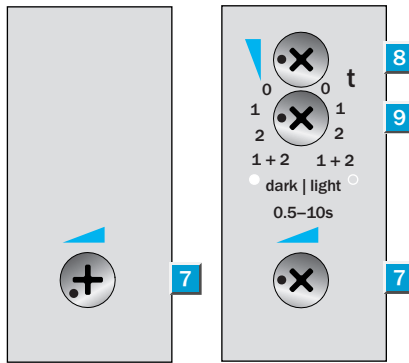

- 1 Standard direction of the material being scanned
- 2 Optical axis sender
- 3 Optical axis receiver
- 4 Mounting hole Ø 5.2 mm
- 5 LED indicator green; power on
- 6 LED indicator yellow; status of received light beam
- 7 Adjustment of scanning distance: Poti
- 8 Time control
- 9 Time delay selector switch
- 0 Light-switching (L)
- Dark-switching (D)

Switch-selectable time delay

D L	0.5 - 10s
0 0	Without time delay
2 1	Time delay from trailing edge of object
1 2	Time delay from leading edge of object
1 + 2	Time delay from trailing and leading edge of object



Connection type

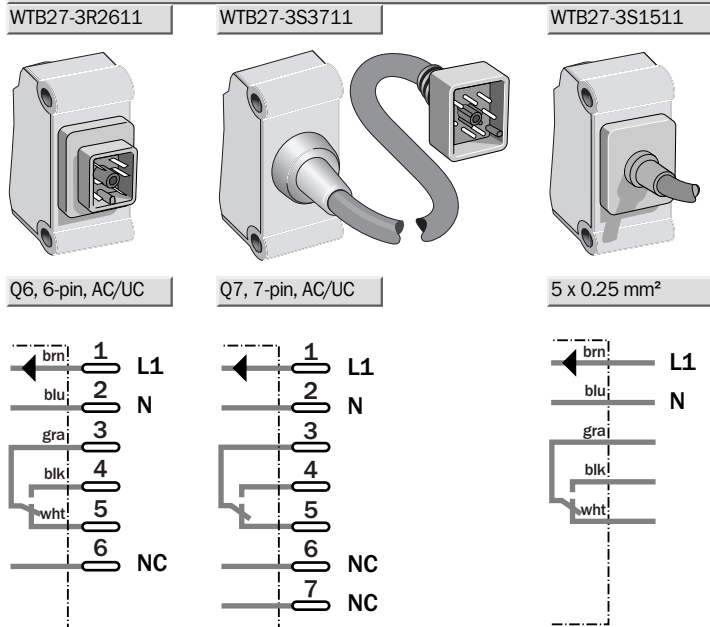

See chapter Accessories*

Connector, Q6, 6-pin, UC-coding
Connector, Q7, 7-pin, UC-coding
Mounting systems
Weather protection

* Recommendation for connectors:



Technical data		WTB27-3	R2611	S1511	S3711								
Scanning distance typ. max.	30 ... 1,600 mm ¹⁾												
Operating distance	100 ... 1,600 mm ¹⁾												
Adjustment of operating distance	Potentiometer												
Light source, light type	LED, Infrared light, 880 nm ²⁾												
Light spot diameter	Approx. 25 mm at 800 mm distance												
Supply voltage V _s	24 ... 240 V UC ³⁾												
Switching outputs	Relay 1 x c/o, electrically isolated ⁴⁾												
	Relay 1 x c/o, electrically isolated ⁵⁾												
Switching mode	Light-/dark-switching, switchable												
	Light-switching												
Power consumption	≤ 2.5 VA												
Max. switching voltage	250 V AC / 250 V DC (max. 0.11A)												
Switching current max.	3 A @ 250 V AC o. 24 V DC ⁶⁾												
Max. switching power	750 W AC / 72 W DC												
Response time	≤ 10 ms												
Switching frequency	10 Hz ⁷⁾												
Time delay	Selectable: 0.5...10s												
Time type	OFF, T _{off} , T _{on} , T _{off} + T _{on}												
Connection type	Connector, Q6, 6-pin, AC/UC												
	Cable, PVC, 2 m ⁸⁾												
	Cable with plug, Q7, 7-pin, AC/UC, PVC, 150 mm ⁸⁾												
VDE protection class	□ ⁹⁾												
Circuit protection	V _s connections reverse-polarity protected / Interference suppression												
Enclosure rating	IP 65												
	IP 66, IP 67												
Ambient temperature operation	-40 °C ... +60 °C ¹⁰⁾												
Ambient temperature storage	-40 °C ... +75 °C												
Weight	Approx. 120 g												
	Approx. 200 g												
	Approx. 140 g												
Housing material	ABS, PMMA												

¹⁾ Object with 90 % remission (based on standard white to DIN 5033)

²⁾ Average service life 100,000 h at T_a = +25 °C

³⁾ ± 10%

⁴⁾ Provide suitable spark suppression for inductive or capacitive loads. Relay contacts are separated from the power supply by basic isolation of 3 mm. Depending on the application, additional

isolation might have to be applied in the user's circuit

⁵⁾ Provide suitable spark suppression for inductive or capacitive loads

⁶⁾ Usage category to EN 60947-1,

AC-15, DC-13

⁷⁾ with light/dark ratio 1:1

⁸⁾ do not bend below 0 °C

⁹⁾ Reference voltage 250 V AC

¹⁰⁾ UL: 0 °C ... +60 °C

Scanning distance

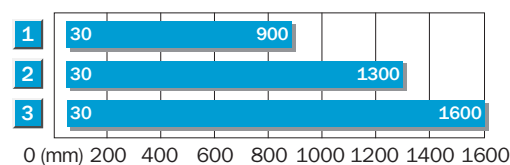

- 1 Scanning distance on black, 6 % remission
- 2 Scanning distance on grey, 18 % remission
- 3 Scanning distance on white, 90 % remission

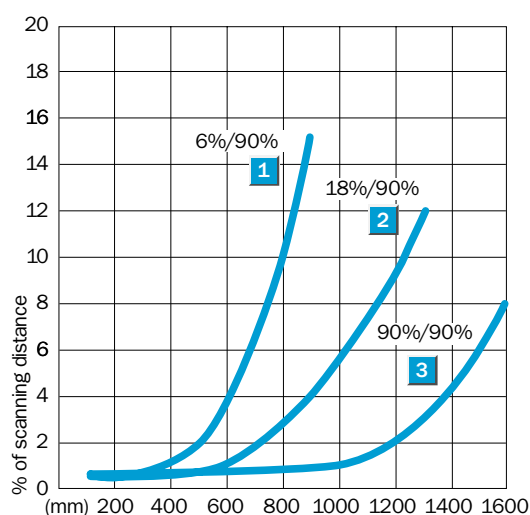

Order information

Type	Order no.
WTB27-3R2611	1 027 763
WTB27-3S1511	1 027 762
WTB27-3S3711	1 027 764

Photoelectric reflex switch, WL27-3, red light - DC

Scanning range
0.1 ... 15 m

Photoelectric reflex switch

- Red light for easier alignment
- Long range, high operating reserve
- Reliable in industrial environments; secure against the effects of ambient light, other sensors mounted adjacently and temperatures from -40 °C ... +60 °C
- Front screen heating, time delays

Dimensional drawing

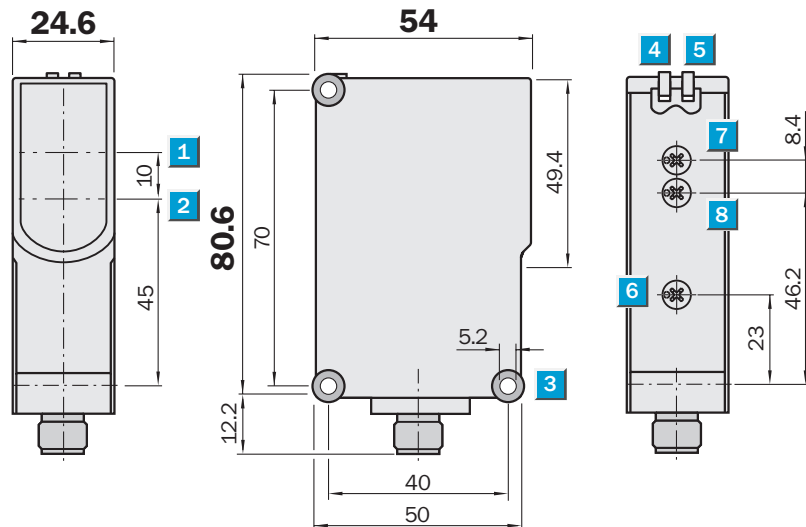

Adjustments possible

WL27-3P1131	WL27-3E2631
WL27-3P2431	WL27-3F2631
WL27-3P2451	

- 1 Optical axis sender
- 2 Optical axis receiver
- 3 Mounting hole Ø 5.2 mm
- 4 LED indicator green; power on
- 5 LED indicator yellow; status of received light beam
- 6 Sensitivity adjustment: Poti
- 7 Time control
- 8 Time delay selector switch

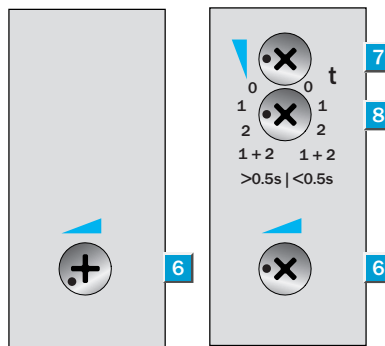

Switch-selectable time delay

0.02 - 0.5s or 0.5 - 10s

- 0 Without time delay
- 1 Time delay from trailing edge of object
- 2 Time delay from leading edge of object
- 1 + 2 Time delay from trailing and leading edge of object



Connection type

WL27-3P3730	WL27-3P2430	WL27-3E2631	WL27-3P1131
	WL27-3P2431	WL27-3F2631	
	WL27-3P2450		
	WL27-3P2451		

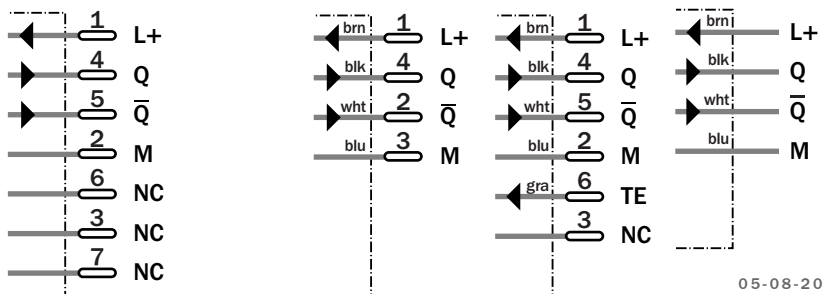
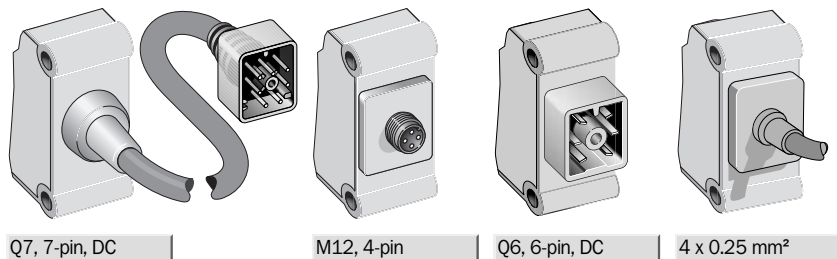

See chapter Accessories

Connector, M12, 4-pin
Connector, Q6, 6-pin, DC-coding
Connector, Q7, 7-pin, DC-coding
Mounting systems
Reflectors
Weather protection

Technical data		WL27-3	E2631	F2631	P1131	P2430	P2431	P2450	P2451	P3730		
Scanning range typ. max.	0.1 ... 15 m											
Scanning range, recommended	0.1 ... 11 m											
Relating to	Reflector PL80 A											
Sensitivity adjustment	Potentiometer											
Light source, light type	LED, Red light, 660 nm ¹⁾											
Light spot diameter	Approx. 220 mm at 10 m distance											
Angle of dispersion	Approx. 1.5 °											
Polarisation filter	✓											
Supply voltage V _s	10 ... 30 V DC ²⁾											
Ripple	≤ 5 V _{pp} ³⁾											
Power consumption	≤ 45 mA ⁴⁾ ≤ 30 mA ⁴⁾											
Switching outputs	NPN antivalent PNP antivalent											
Signal voltage PNP HIGH / LOW	> V _s - 2.5 V / approx. 0 V											
Signal voltage NPN HIGH / LOW	Approx. V _s / < 2.5 V											
Output current I _a max	100 mA											
Response time	≤ 500 μs ⁵⁾											
Switching frequency	1,000 Hz ⁶⁾											
Time delay	Selectable: 0.5 ... 10 s / 0.02 ... 0.5 s											
Time type	OFF, T _{off} , T _{on} , T _{off} + T _{on}											
Test input sender off	TE to V _s TE to 0 V											
Connection type	Connector, Q6, 6-pin, DC Cable, PVC, 2 m ⁷⁾ Connector, M12, 4-pin Cable with plug, Q7, 7-pin, DC, PVC, VDE protection class											
VDE protection class	□ ⁸⁾											
Circuit protection	V _s connections reverse-polarity protected / All outputs short-circuit protected / Interference suppression											
Enclosure rating	IP 65 IP 66, IP 67											
Ambient temperature operation	-40 °C ... +60 °C											
Ambient temperature storage	-40 °C ... +75 °C											
Weight	Approx. 100 g Approx. 180 g Approx. 120 g											
Front screen heating	✓											
Housing material	ABS, PMMA											

¹⁾ Average service life 100,000 h at T_a = +25 °C

²⁾ Limit values, operation in short-circuit

³⁾ protected network max. 8 A
³⁾ may not exceed or fall short of

V_s tolerances
⁴⁾ without load
⁵⁾ Signal transit time with resistive load

⁶⁾ with light/dark ratio 1:1
⁷⁾ do not bend below 0 °C
⁸⁾ Reference voltage 50 V DC

Scanning range and operating reserve

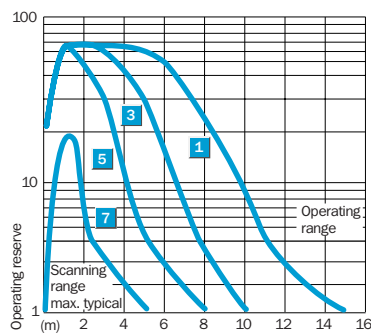
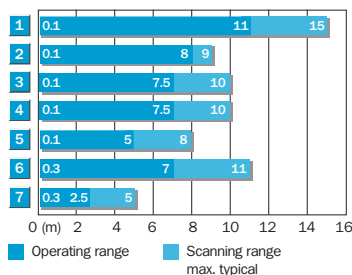

Reflector type	Operating range
1	PL 80 A 0.1 ... 11.0 m
2	PL 50 A 0.1 ... 8.0 m
3	PL 40 A 0.1 ... 7.5 m
4	PL 30 A 0.1 ... 7.5 m
5	PL 20 A 0.1 ... 5.0 m
6	C 110 0.3 ... 7.0 m
7	Reflective tape Diamond Grade 0.3 ... 2.5 m

Order information

Type	Order no.
WL27-3E2631	1 027 773
WL27-3F2631	1 027 772
WL27-3P1131	1 027 768
WL27-3P2430	1 027 769
WL27-3P2431	1 027 982
WL27-3P2450	1 027 771
WL27-3P2451	1 027 770
WL27-3P3730	1 027 774

Photoelectric reflex switch, WL27-3, red light - UC

Scanning range
0.1 ... 15 m
Photoelectric reflex switch

- Universal supply voltage
- Red light for easier alignment
- Reliable in industrial environments; secure against the effects of ambient light, other sensors mounted adjacently and temperatures from -40 °C ... +60°C
- Time delays

Dimensional drawing

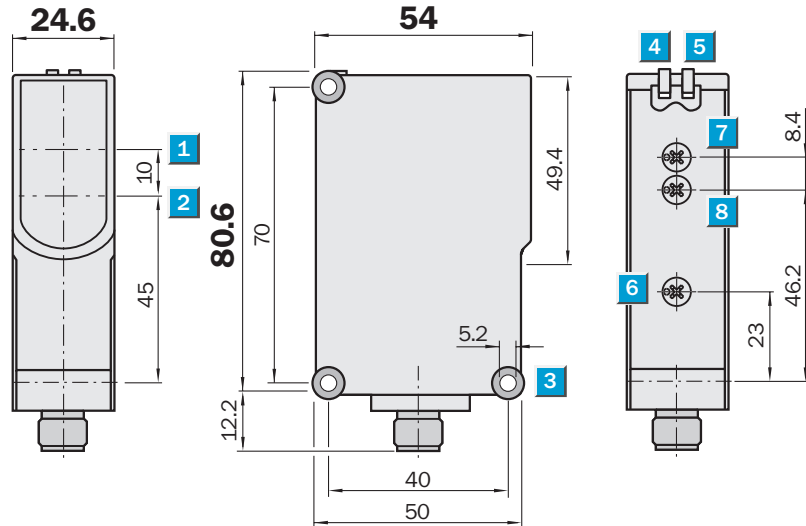

Adjustments possible

WL27-3S1531
 WL27-3S3731

WL27-3R2631

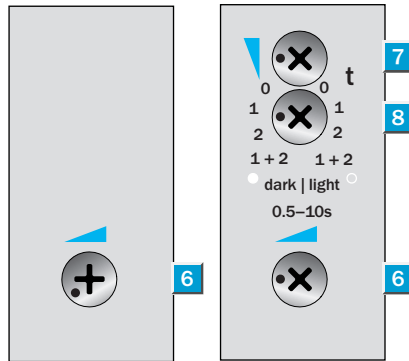

- 1 Optical axis sender
- 2 Optical axis receiver
- 3 Mounting hole Ø 5.2 mm
- 4 LED indicator green; power on
- 5 LED indicator yellow; status of received light beam
- 6 Sensitivity adjustment: Poti
- 7 Time control
- 8 Time delay selector switch
- 0 Light-switching (L)
- Dark-switching (D)



Switch-selectable time delay

D L	0.5 - 10s
0 0	Without time delay
2 1	Time delay from trailing edge of object
1 2	Time delay from leading edge of object
1 + 2	Time delay from trailing and leading edge of object

Connection type

WL27-3R2631

WL27-3S3731

WL27-3S1531

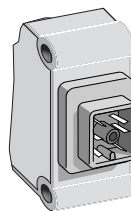

Q6, 6-pin, AC/UC

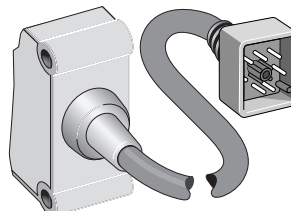

Q7, 7-pin, AC/UC

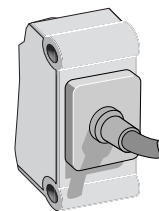

5 x 0.25 mm²

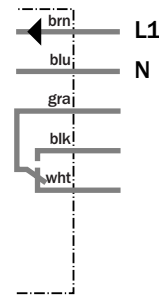
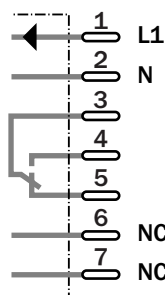
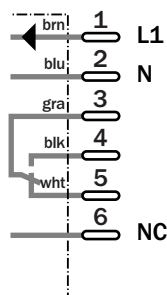

See chapter Accessories*

- Connector, Q6, 6-pin, UC-coding
- Connector, Q7, 7-pin, UC-coding
- Mounting systems
- Reflectors
- Weather protection

* Recommendation for connectors:

AWM Style 2464

Technical data		WL27-3	R2631	S1531	S3731						
Scanning range typ. max.	0.1 ... 15 m										
Scanning range, recommended	0.1 ... 11 m										
Relating to	Reflector PL80 A										
Sensitivity adjustment	Potentiometer										
Light source, light type	LED, Red light, 660 nm ¹⁾										
Light spot diameter	Approx. 220 mm at 10 m distance										
Angle of dispersion	Approx. 1.5 °										
Polarisation filter	✓										
Supply voltage V_s	24 ... 240 V UC ²⁾										
Switching outputs	Relay 1 x c/o, electrically isolated ³⁾										
	Relay 1 x c/o, electrically isolated ⁴⁾										
Switching mode	Light-/dark-switching, selectable										
	Light-switching										
Power consumption	≤ 2.5 VA										
Max. switching voltage	250 V AC / 250 V DC (max. 0.11 A)										
Switching current max.	3 A @ 250 V AC o. 24 V DC ⁵⁾										
Max. switching power	750 W AC / 72 W DC										
Response time	≤ 10 ms										
Switching frequency	10 Hz ⁶⁾										
Time delay	Selectable: 0.5 ... 10 s										
Time type	OFF, T _{off} , T _{on} , T _{off} + T _{on}										
Connection type	Connector, Q6, 6-pin, AC/UC										
	Cable, PVC, 2 m ⁷⁾										
	Cable with plug, Q7, 7-pin, AC/UC, PVC, 150 mm ⁷⁾										
VDE protection class	□ ⁸⁾										
Circuit protection	V _s connections reverse-polarity protected / Interference suppression										
Enclosure rating	IP 65										
	IP 66, IP 67										
Ambient temperature operation	-40 °C ... +60 °C ⁹⁾										
Ambient temperature storage	-40 °C ... +75 °C										
Weight	Approx. 120 g										
	Approx. 200 g										
	Approx. 140 g										
Housing material	ABS, PMMA										

¹⁾ Average service life 100,000 h at T_a = +25 °C

²⁾ ± 10 %

³⁾ Provide suitable spark suppression for

inductive or capacitive loads. Relay contacts are separated from the power supply by a basic isolation of 3 mm. Depending on the application, additional

isolation might have to be applied in the user's circuit
⁴⁾ Provide suitable spark suppression for inductive or capacitive loads

⁵⁾ Usage category to EN 60947-1, AC-15, DC-13

⁶⁾ with light/dark ratio 1:1
⁷⁾ do not bend below 0 °C

⁸⁾ Reference voltage 250 V AC

Scanning range and operating reserve

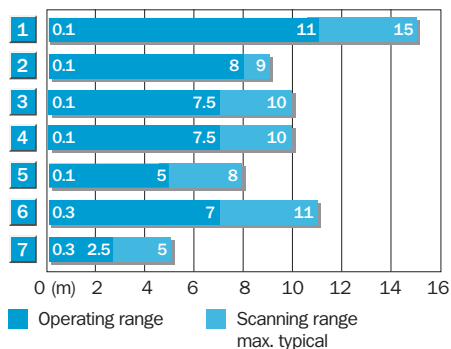

Reflector type	Operating range
1	PL 80 A 0.1 ... 11.0 m
2	PL 50 A 0.1 ... 8.0 m
3	PL 40 A 0.1 ... 7.5 m
4	PL 30 A 0.1 ... 7.5 m
5	PL 20 A 0.1 ... 5.0 m
6	C 110 0.3 ... 7.0 m
7	Reflective tape Diamond Grade 0.3 ... 2.5 m

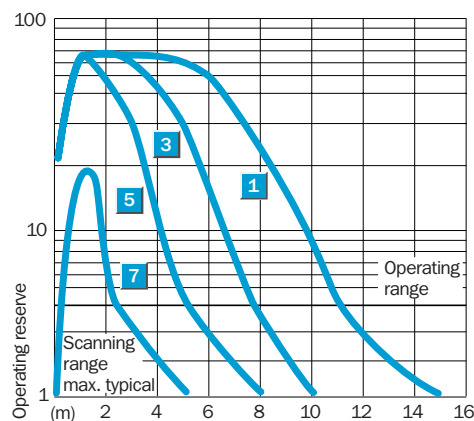

Order information

Type	Order no.
WL27-3R2631	1 027 776
WL27-3S1531	1 027 775
WL27-3S3731	1 027 777

Through-beam photoelectric switch, WSE27-3, red light - DC



Scanning range
0 ... 35 m

Through-beam photoelectric switch

- Red light for easier alignment
- Long range, high operating reserve
- Reliable in industrial environments; secure against the effects of ambient light and temperatures from -40 °C ... +60 °C
- Alarm output, front screen heating, test input, time delays

Dimensional drawing

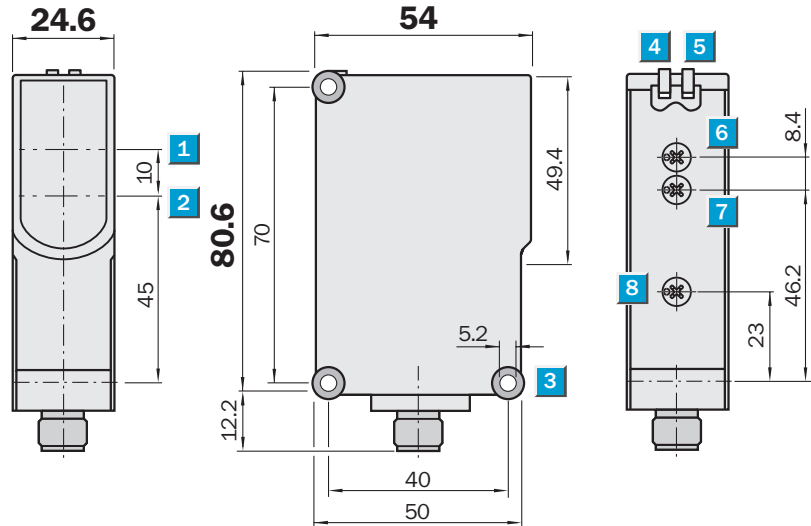

Adjustments possible

WSE27-3E2631	WSE27-3P2430
WSE27-3F2631	WSE27-3P2450
	WSE27-3P3730

- 1 Optical axis sender
- 2 Optical axis receiver
- 3 Mounting hole \varnothing 5.2 mm
- 4 LED indicator green; power on
- 5 LED indicator yellow; status of received light beam
- 6 Time control
- 7 Time delay selector switch
- 8 Sensitivity adjustment: Poti

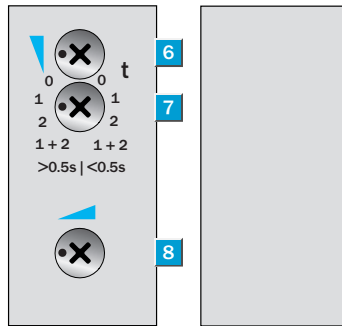

Switch-selectable time delay

0.02 - 0.5s or 0.5 - 10s

- 0 Without time delay
- 1 Time delay from trailing edge of object
- 2 Time delay from leading edge of object
- 1 + 2 Time delay from trailing and leading edge of object

Connection type

WSE27-3P3730	WSE27-3P2430 WSE27-3P2450	WSE27-3E2631 WSE27-3F2631
--------------	------------------------------	------------------------------

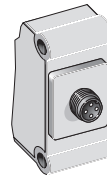
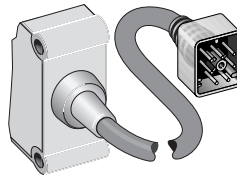

Sender Q7, 7-pin, DC

M12, 4-pin

Q6, 6-pin, DC

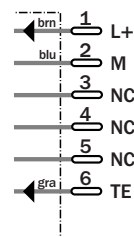
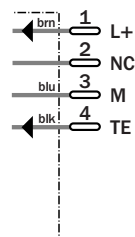
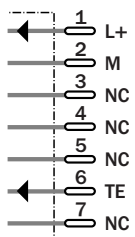

Receiver Q7, 7-pin, DC

M12, 4-pin

Q6, 6-pin, DC

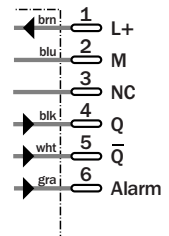
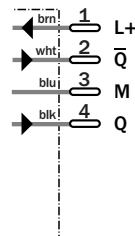
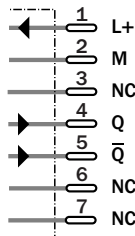

See chapter Accessories

- Connector, M12, 4-pin
- Connector, Q6, 6-pin, DC-coding
- Connector, Q7, 7-pin, DC-coding
- Mounting systems
- Weather protection

Technical data		WSE27-3	E2631	F2631	P2430	P2450	P3730						
Scanning range typ. max.	0 ... 35 m												
Scanning range, recommended	0 ... 25 m												
Sensitivity adjustment	Potentiometer												
Light source, light type	LED, Red light, 645 nm ¹⁾												
Light spot diameter	Approx. 600 mm at 25 m distance												
Angle of dispersion	Approx. 1.5 °												
Angle of reception	Approx. 3 °												
Supply voltage V _s	10 ... 30 V DC ²⁾												
Ripple	≤ 5 V _{pp} ³⁾												
Power consumption, sender	≤ 35 mA without front screen heating												
	≤ 50 mA with front screen heating												
Power consumption, receiver	≤ 20 mA without front screen heating ⁴⁾												
	≤ 35 mA with front screen heating ⁴⁾												
Switching outputs	NPN antivalent												
	PNP antivalent												
Signal voltage PNP HIGH / LOW	> V _s - 2.5 V / approx. 0 V												
Signal voltage NPN HIGH / LOW	Approx. V _s / < 2.5 V												
Output current I _a max	100 mA												
Response time	≤ 500 μs ⁵⁾												
Switching frequency	1,000 Hz ⁶⁾												
Time delay	Selectable: 0.5 ... 10 s / 0.02 ... 0.5 s												
Time type	OFF, T _{off} , T _{on} , T _{off} + T _{on}												
Test input sender off	TE to 0 V												
Alarm output	Alarm ⁷⁾												
Connection type	Connector, Q6, 6-pin, DC												
	Connector, M12, 4-pin												
	Cable with plug, Q7, 7-pin, DC, PVC, 150 mm ⁸⁾												
VDE protection class	□ ⁹⁾												
Circuit protection	V _s connections reverse-polarity protected / All outputs short-circuit protected / Interference suppression												
Enclosure rating	IP 65												
	IP 66, IP 67												
Ambient temperature operation	-40 °C ... +60 °C												
Ambient temperature storage	-40 °C ... +75 °C												
Weight	Approx. 200 g												
	Approx. 240 g												
Front screen heating	✓												
Housing material	ABS, PMMA												

¹⁾ Average service life 100,000 h
at T_a = +25 °C

²⁾ Limit values, operation in short-circuit

protected network max. 8 A
³⁾ may not exceed or fall short of
V_s tolerances

⁴⁾ without load

⁵⁾ Signal transit time with resistive load

⁶⁾ with light/dark ratio 1:1

⁷⁾ NPN: Signal reserve > 50 % HIGH.

PNP: Signal reserve > 50 % LOW

⁸⁾ do not bend below 0 °C

⁹⁾ Reference voltage 50 V DC

Scanning range and operating reserve

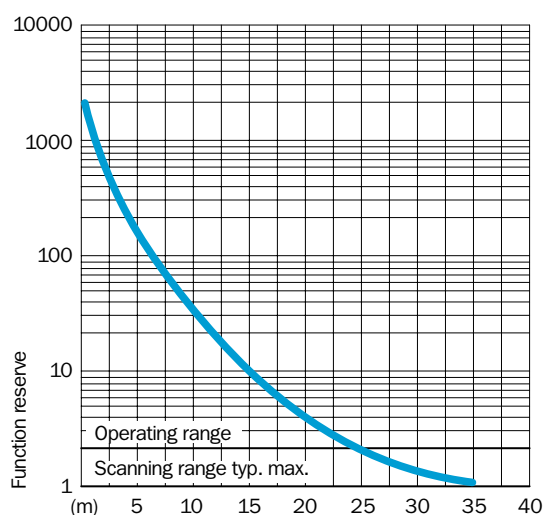
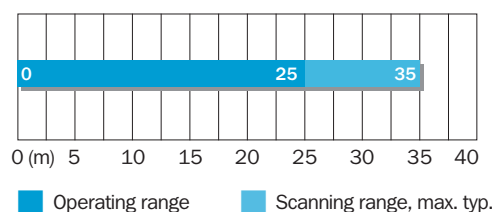

Order information

Type	Order no.
WSE27-3E2631	1 027 793
WSE27-3F2631	1 027 792
WSE27-3P2430	1 027 790
WSE27-3P2450	1 027 791
WSE27-3P3730	1 027 794

Through-beam photoelectric switch, WSE27-3, red light - UC

Scanning range
0 ... 35 m

Through-beam photoelectric switch

- Universal supply voltage
- Red light for easier alignment
- Long range, high operating reserve
- Reliable in industrial environments; secure against the effects of ambient light and temperatures from -40 °C ... +60 °C
- Time delays

Dimensional drawing

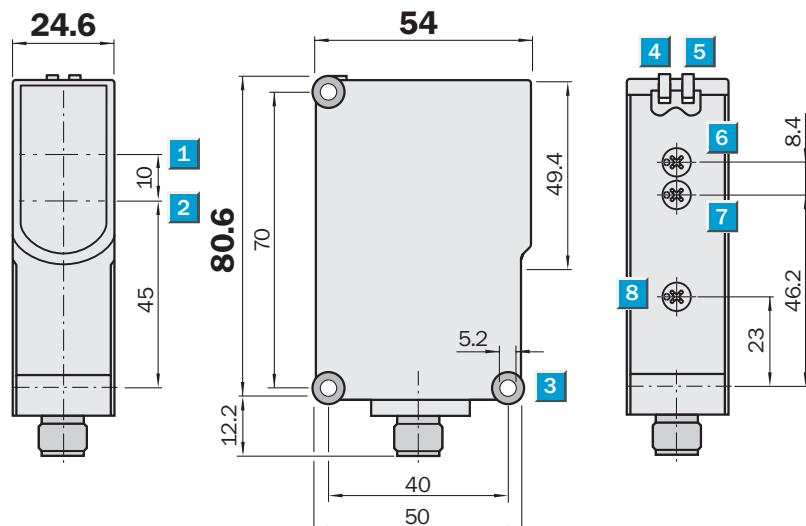

Adjustments possible

WSE27-3R2631

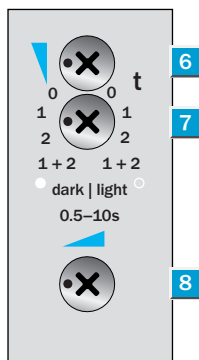

- 1 Optical axis sender
- 2 Optical axis receiver
- 3 Mounting hole Ø 5.2 mm
- 4 LED indicator green; power on
- 5 LED indicator yellow; status of received light beam
- 6 Time control
- 7 Time delay selector switch
- 8 Sensitivity adjustment: Poti
- 0 Light-switching (L)
- Dark-switching (D)

Switch-selectable time delay

D L	0.5 - 10s
0 0	Without time delay
2 1	Time delay from trailing edge of object
1 2	Time delay from leading edge of object
1 + 2	Time delay from trailing and leading edge of object



Connection type

WSE27-3R2631

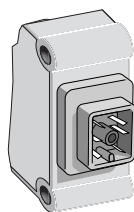

Q6, 6-pin, AC/UC

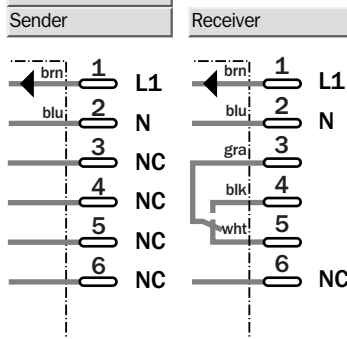

See chapter Accessories*

Connector, Q6, 6-pin, UC-coding

Mounting systems

Weather protection

* Recommendation for connectors:

AWM Style 2464

Technical data		WSE27-3	R2631												
Scanning range typ. max.	0 ... 35 m														
Scanning range, recommended	0 ... 25 m														
Sensitivity adjustment	Potentiometer														
Light source, light type	LED, Red light, 645 nm ¹⁾														
Light spot diameter	Approx. 600 mm at 25 m distance														
Angle of dispersion	Approx. 1.5 °														
Angle of reception	Approx. 3 °														
Supply voltage V_s	24 ... 240 V UC ²⁾														
Switching outputs	Relay 1 x c/o, electrically isolated ³⁾														
Switching mode	Light-/dark-switching, selectable														
Power consumption, sender	≤ 2 VA														
Power consumption, receiver	≤ 2.5 VA														
Max. switching voltage	250 V AC / 250 V DC (max. 0.11 A)														
Switching current max.	3 A @ 250 V AC o. 24 V DC ⁴⁾														
Max. switching power	750 AC / 72 W DC														
Response time	≤ 10 ms ⁵⁾														
Switching frequency	10 Hz ⁶⁾														
Time delay	Selectable: 0.5 ... 10 s														
Time type	OFF, T _{off} , T _{on} , T _{off} + T _{on}														
Connection type	Connector, Q6, 6-pin, AC/UC														
VDE protection class	□ ⁷⁾														
Circuit protection	V _s connections reverse-polarity protected / Interference suppression														
Enclosure rating	IP 65														
Ambient temperature operation	-40 °C ... +60 °C ⁸⁾														
Ambient temperature storage	-40 °C ... +75 °C														
Weight	Approx. 240 g														
Housing material	ABS, PMMA														

¹⁾ Average service life 100,000 h at T_a = +25 °C

²⁾ ± 10 %

³⁾ Provide suitable spark suppression for

inductive or capacitive loads. Relay contacts are separated from the power supply by a basic isolation of 3 mm. Depending on the application, additional

isolation might have to be applied in the user's circuit
⁴⁾ Usage category to EN 60947-1, AC-15, DC-13

⁵⁾ Signal transit time with resistive load
⁶⁾ with light/dark ratio 1:1
⁷⁾ Reference voltage 250 V AC
⁸⁾ UL: 0 °C ... +60 °C

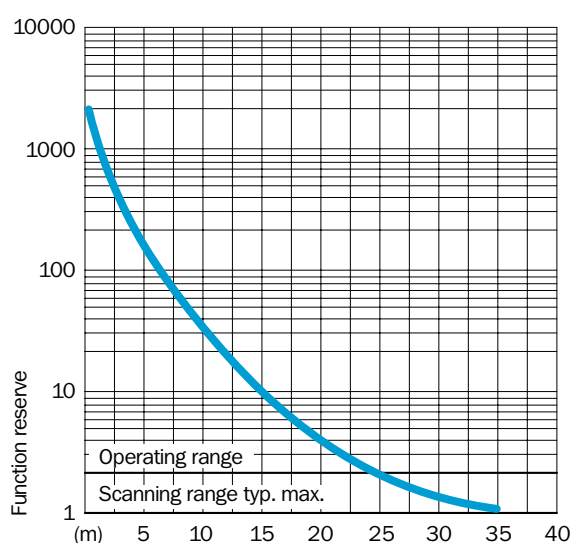
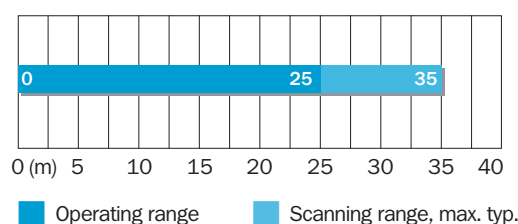

Order information

Type	Order no.
WSE27-3R2631	1 027 795